

A mountain biker wearing a red jersey and helmet is riding a trail on a grassy hillside. The sun is low in the sky, creating a bright starburst effect and casting long shadows. The background features a valley with a lake and distant mountain ranges under a blue sky with scattered clouds.

Ride light

maxon



Swiss drive
technology
for a light
and natural
riding
experience

maxon

- maxon
- maxon BIKEDRIVE AIR
- maxon & Mobilität

Founded in Switzerland
Flourishing around the world



maxon – since 1961

Precision Drive Systems



626

Mio. CHF Turnover



3'200

Staff



10

Production and
R&D Sites



30

Sales Sites

maxon's global network

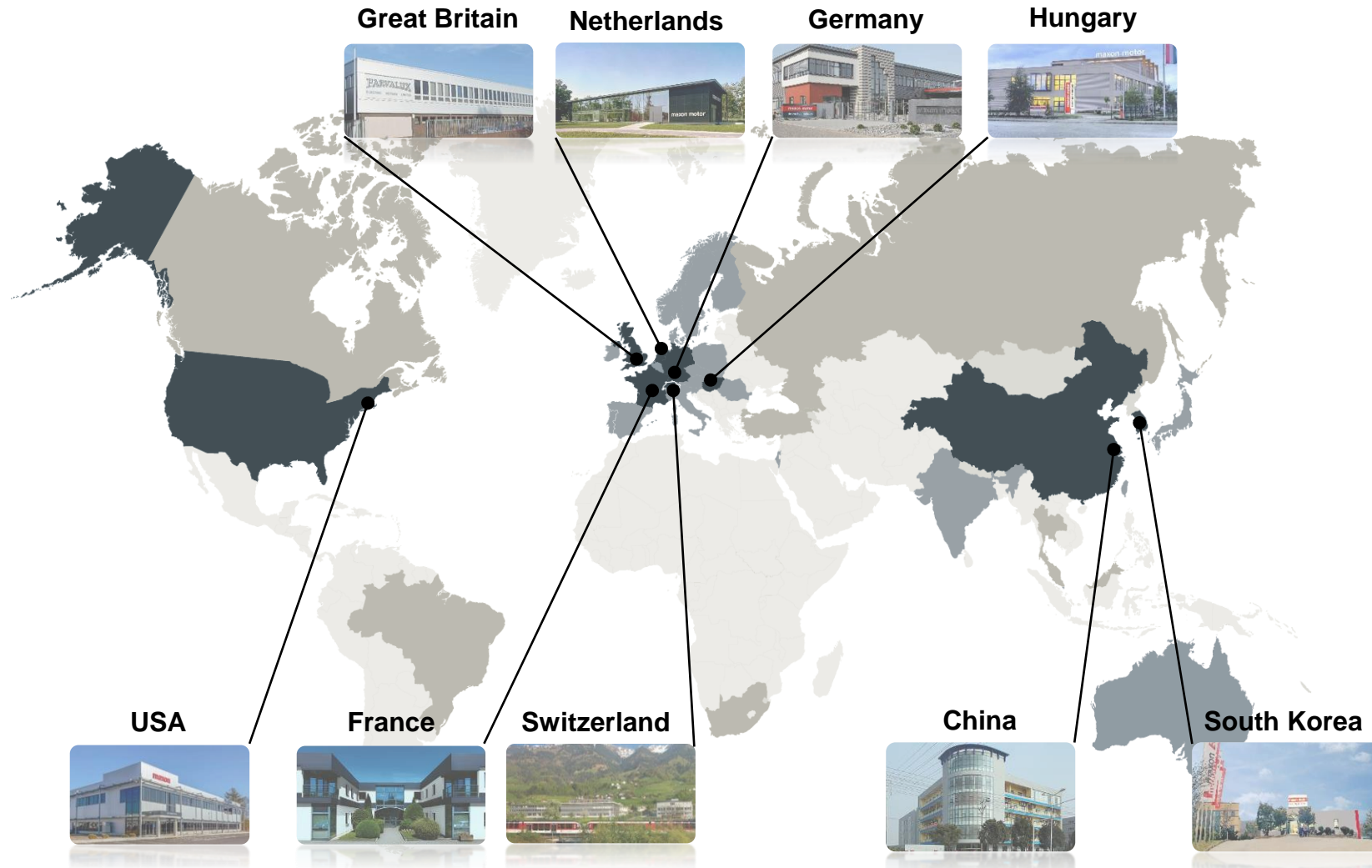

maxon Manufacturing Companies

Switzerland (headquarter)	South Korea	USA
Germany	France	China
Hungary	the Netherlands	Great Britain

maxon Sales Companies

Australia	Hungary	Singapore
Austria	India	Slovakia
Benelux	Ireland	Slovenia
China	Israel	South Korea
Czechia	Italy	Spain
Denmark	Japan	Sweden
Finland	Norway	Switzerland
France	Poland	Taiwan
Germany	Portugal	USA
Great Britain	Romania	

maxon Sales Agents

Brasil	Malaysia	Thailand
Canada	Russia	Turkey
Hong Kong	South Africa	

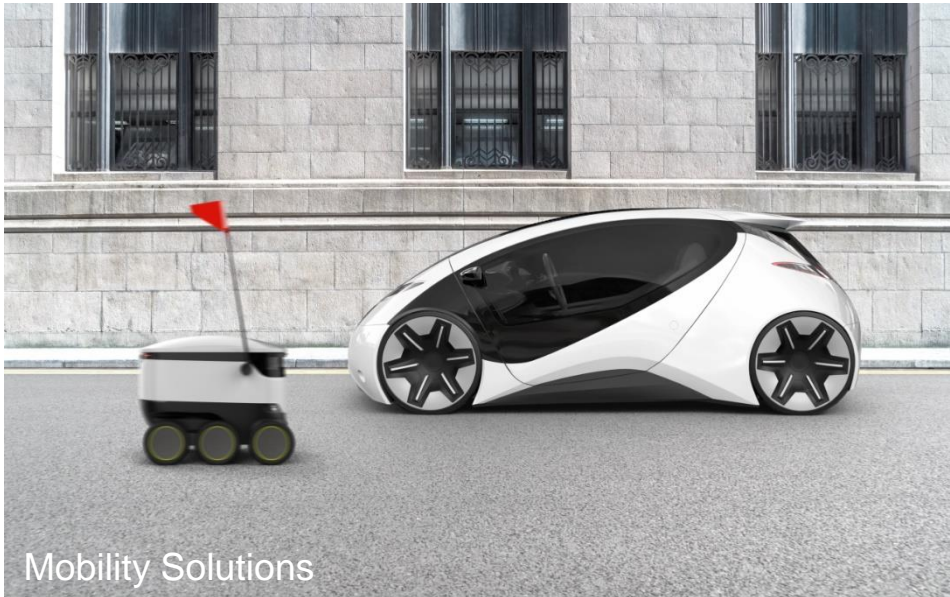

Mobility Solutions



Medical Technology



Industrial Automation



Aerospace

Electric drives for the world – and beyond



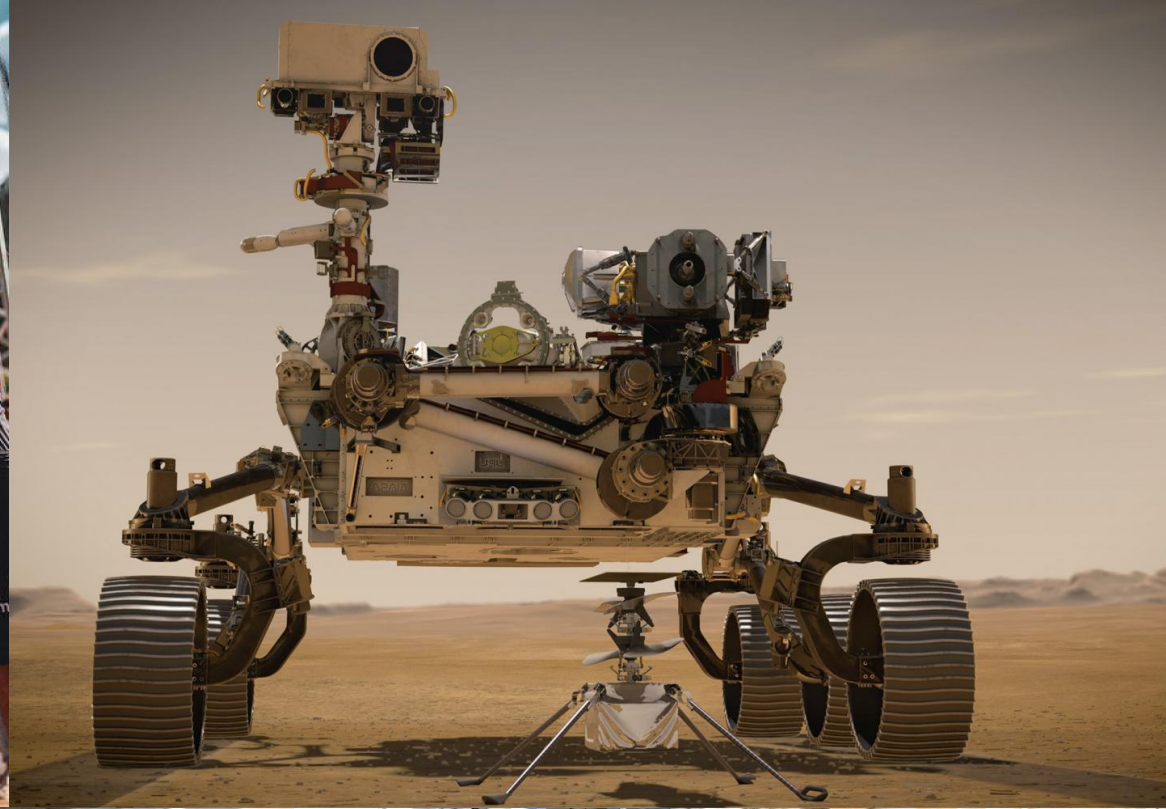

maxon

Wie es anfang

Vom BD Nachrüstkit zum BD AIR

Das E-Bike-Nachrüst-Kit



maxon

A mountain biker wearing a red jersey with 'maxon' and 'E-BIKE ASSIST' logos, a teal helmet, and sunglasses is captured mid-air during a jump. The biker is riding a red Maxon e-bike with 'maxon' branding on the frame and 'SS1115-10T' on the tires. The background consists of a dense forest of green trees under a clear sky. The biker is positioned in the center-right of the frame, with the dirt jump ramp visible at the bottom left.

Let's learn more
about maxon's
lightweight e-bike
assist system

maxon BIKEDRIVE AIR

Fully integrated e-bike system



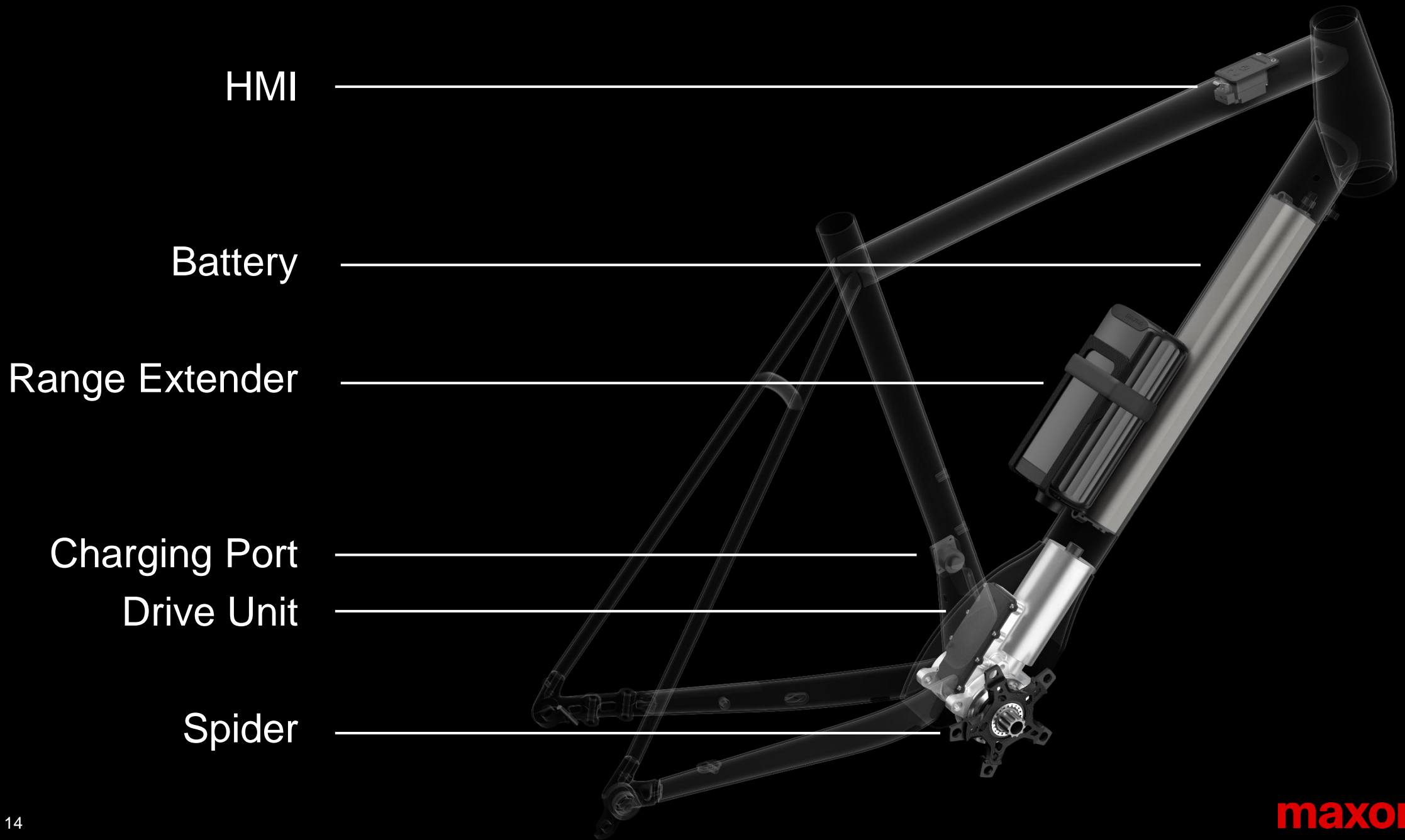

Light weight

- 3.5kg in total

Invisible

- Fully integrated

Natural drivability

- Super smooth rider support
- No drag

Silent riding

Most efficient system



maxon



maxon

Drive Unit:
1.9kg



Battery:

250Wh / 1.4kg

360Wh / 1.8kg



Range Extender:
250Wh / 1.4kg





HMI:
BLE / ANT+



maxon BLE

Mobile App

maxon Bikedrive Support app
maxon Bikedrive Connect app



ANT+ / LEV



SIGMA BLE



maxon

Apps



BIKEDRIVE Connect

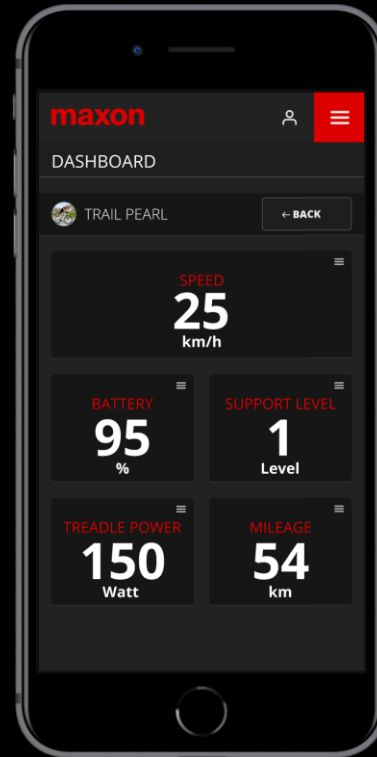

BIKEDRIVE Service

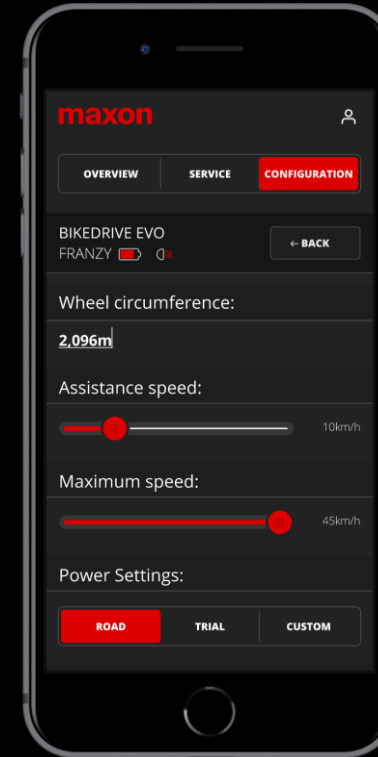

maxon & Mobilität

Komponentenhersteller → Systemanbieter

BD AIR steht für ein komplettes System / einfache und kostengünstige Integration für OEM Kunden. Alles aus einer Hand.

BD AIR ist auch ein Baukasten / spezifische Kunden Entwicklungen sind einfacher umzusetzen --> Motor, Batterie, App etc.

BD AIR schliesst eine Lücke im Fahrradsortiment / anstatt schwer, stark, unhandlich setzen wir auf leicht, kraftvoll, agil



Fly high with the maxon BIKEDRIVE AIR

What drives you?

maxon intl. itd
Brünigstrasse 220
6072 Sachseln
Switzerland

T +41 (0) 41 666 15 00
maxongroup.com

maxon