

Phase change dispersions for temperature-stabilisation

A glance at machine-spindle cooling

Poppy O'Neill, Silvan von Arx, Ludger Fischer

28.01.2022



Overview

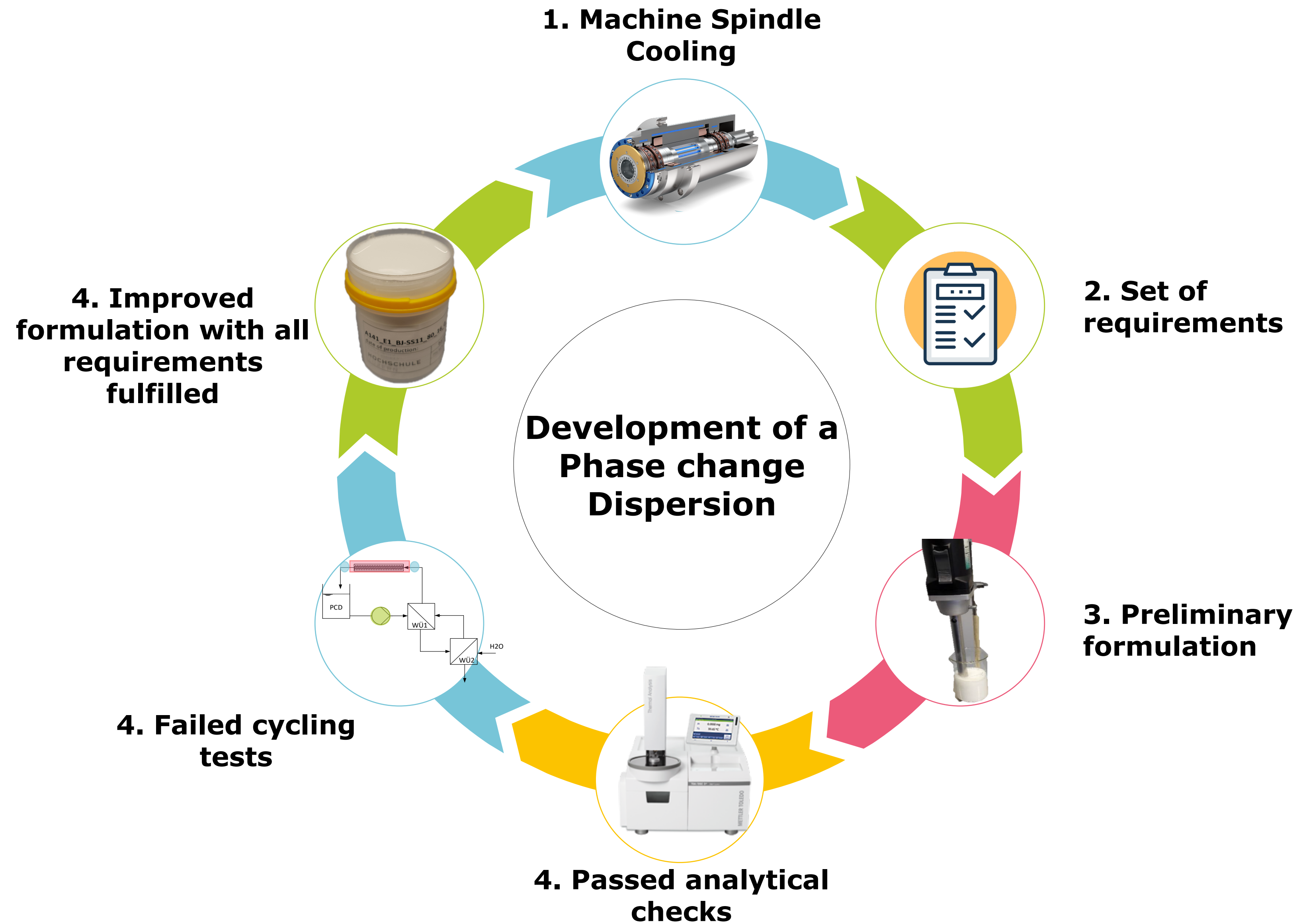

Background : Phase change dispersions

What is a phase change dispersion?

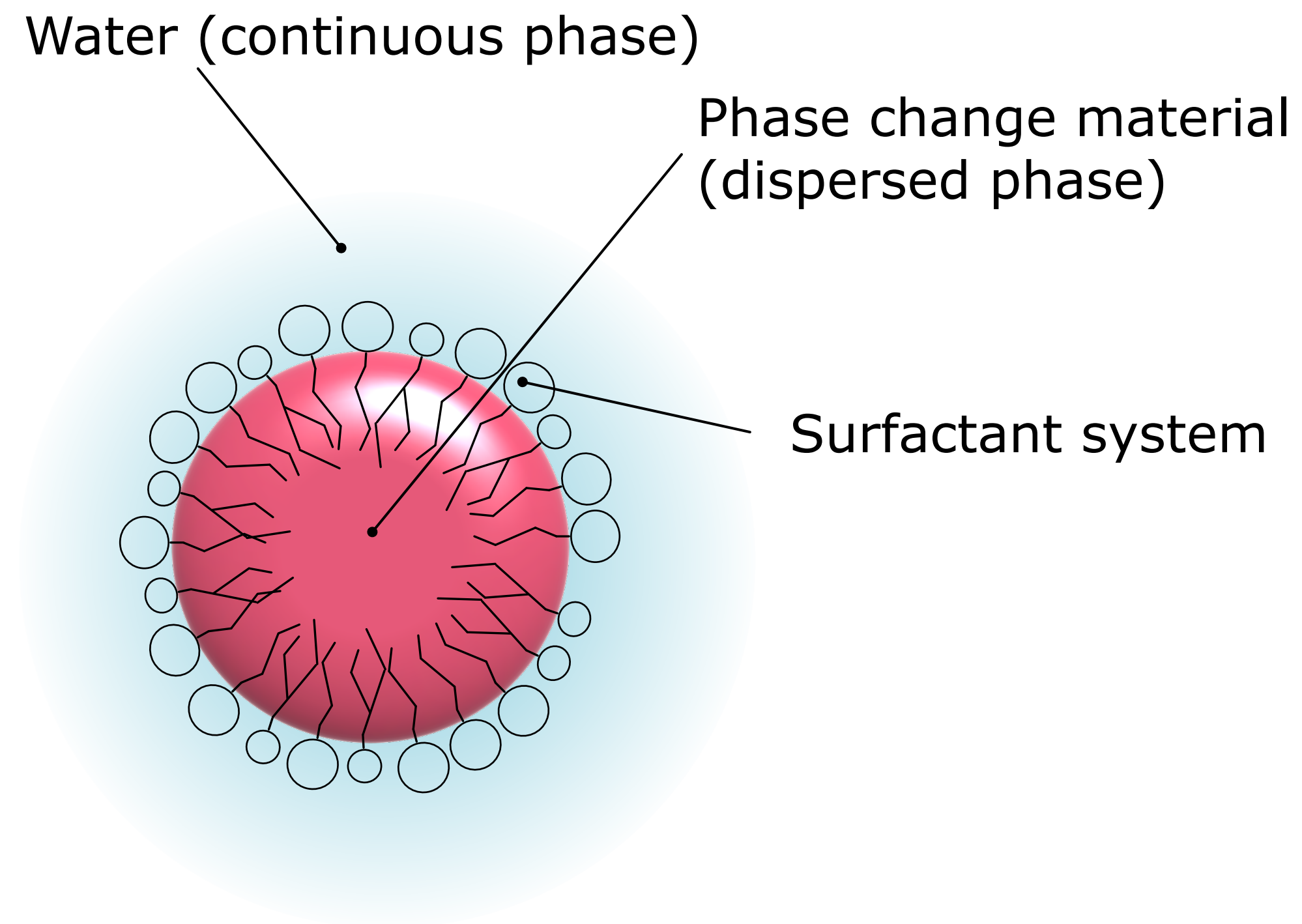

DeltaZero Objective

Formulate and test a novel phase change dispersion which fulfill the following requirements

Requirements:

- $c_p \geq 8 \text{ kJ kg}^{-1} \text{ K}^{-1}$
- Low viscosity (μ)
- Low supercooling
- Thermal stability
- Mechanical stability
- Storage stability
- High heat transfer rate

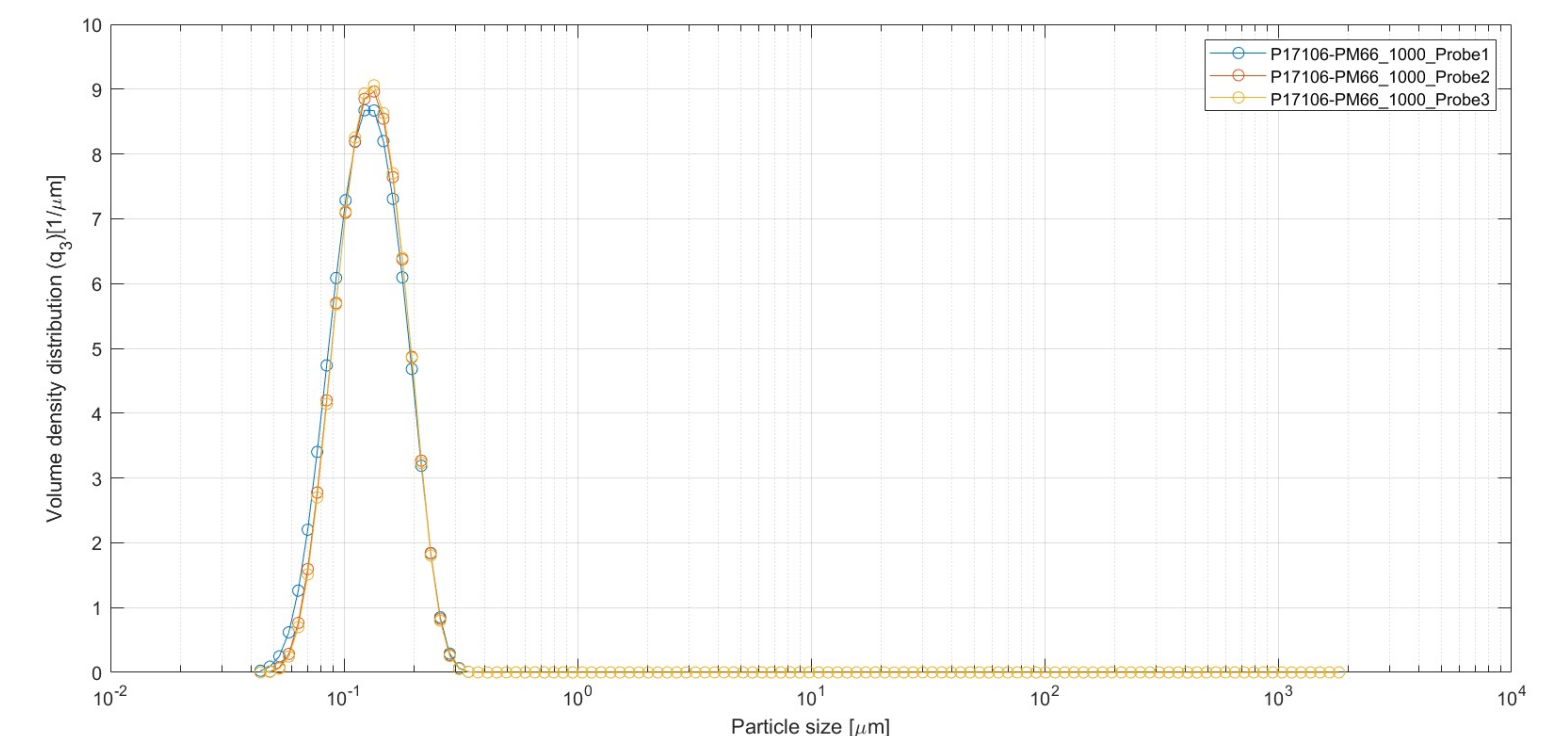
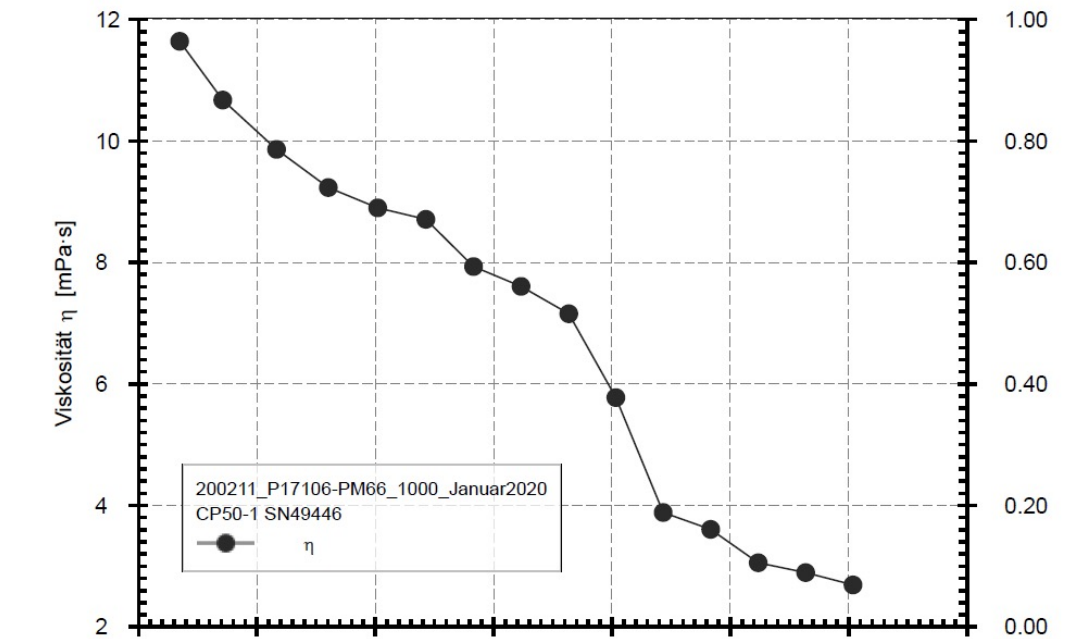
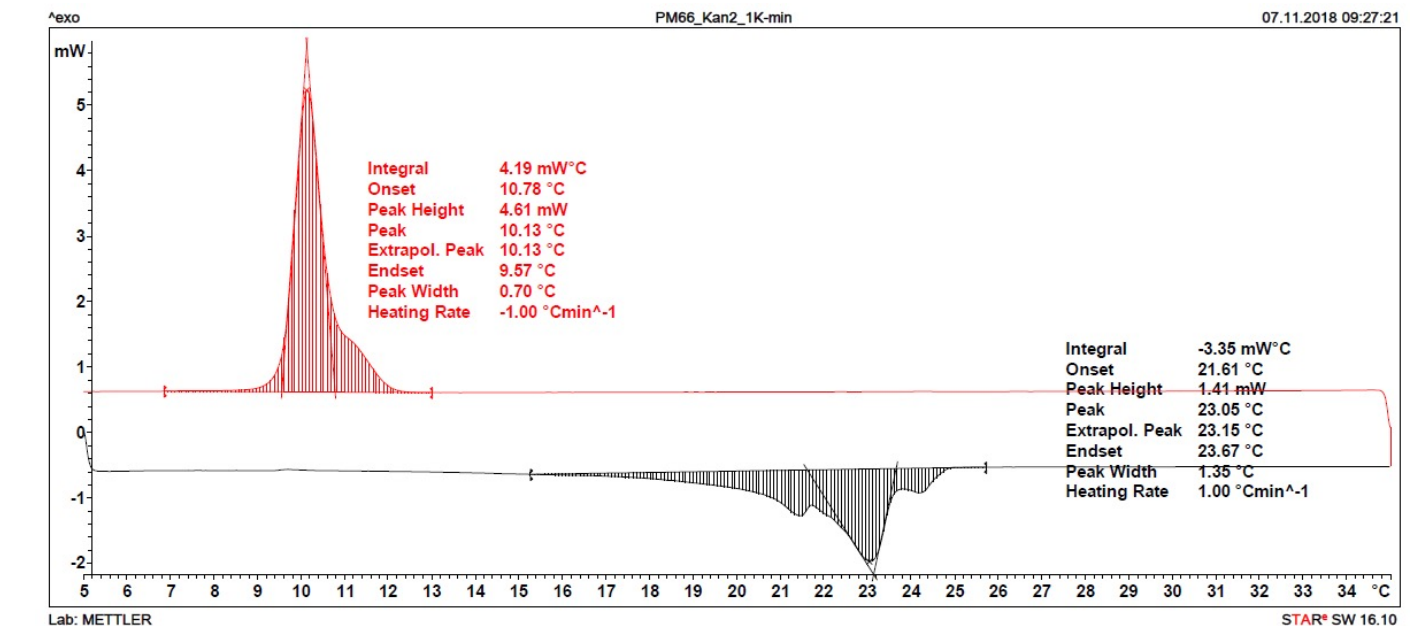
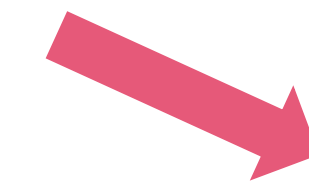
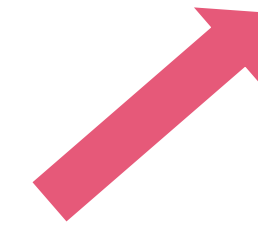
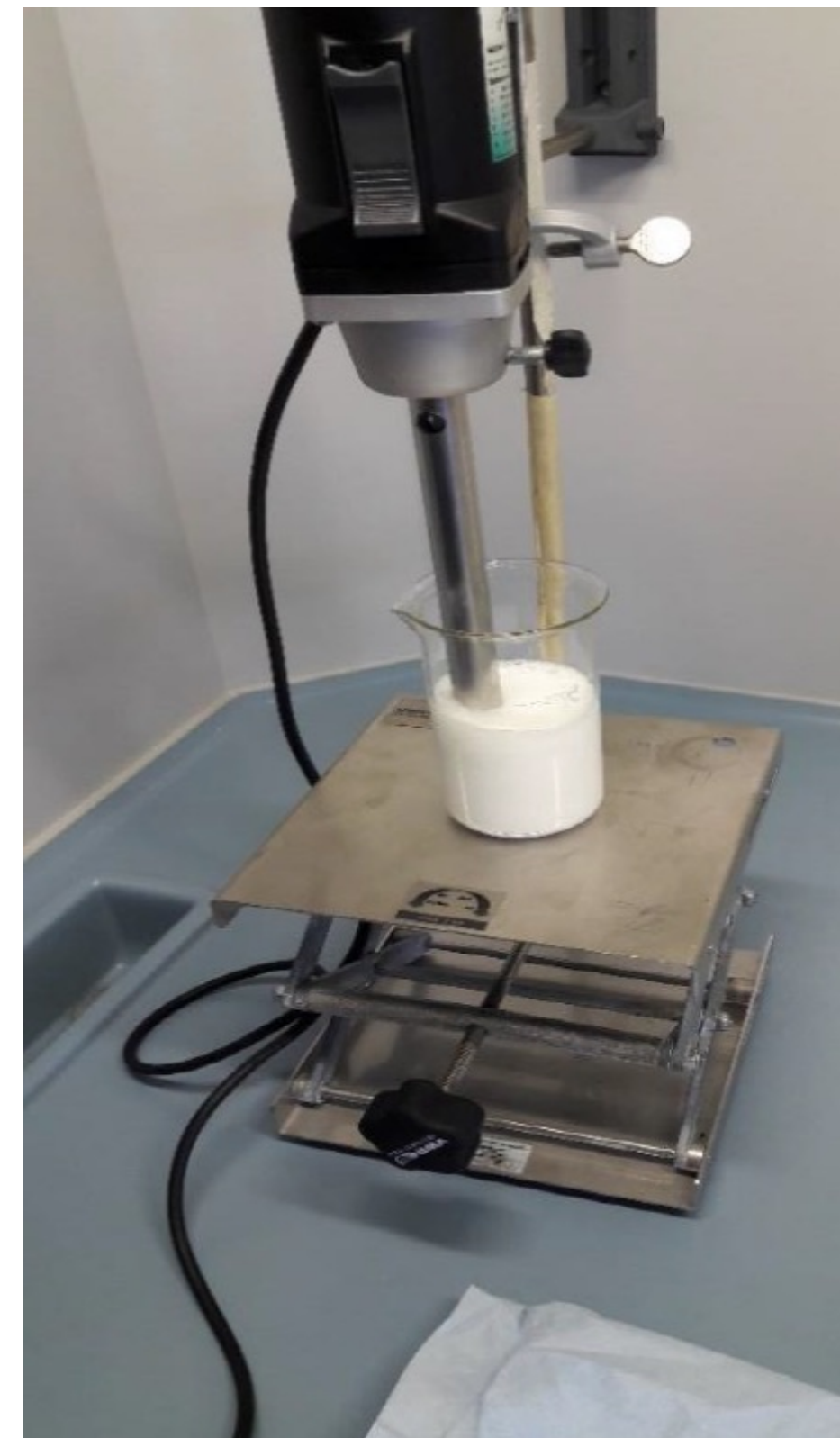

Methodology : Preliminary Phase Change Dispersion

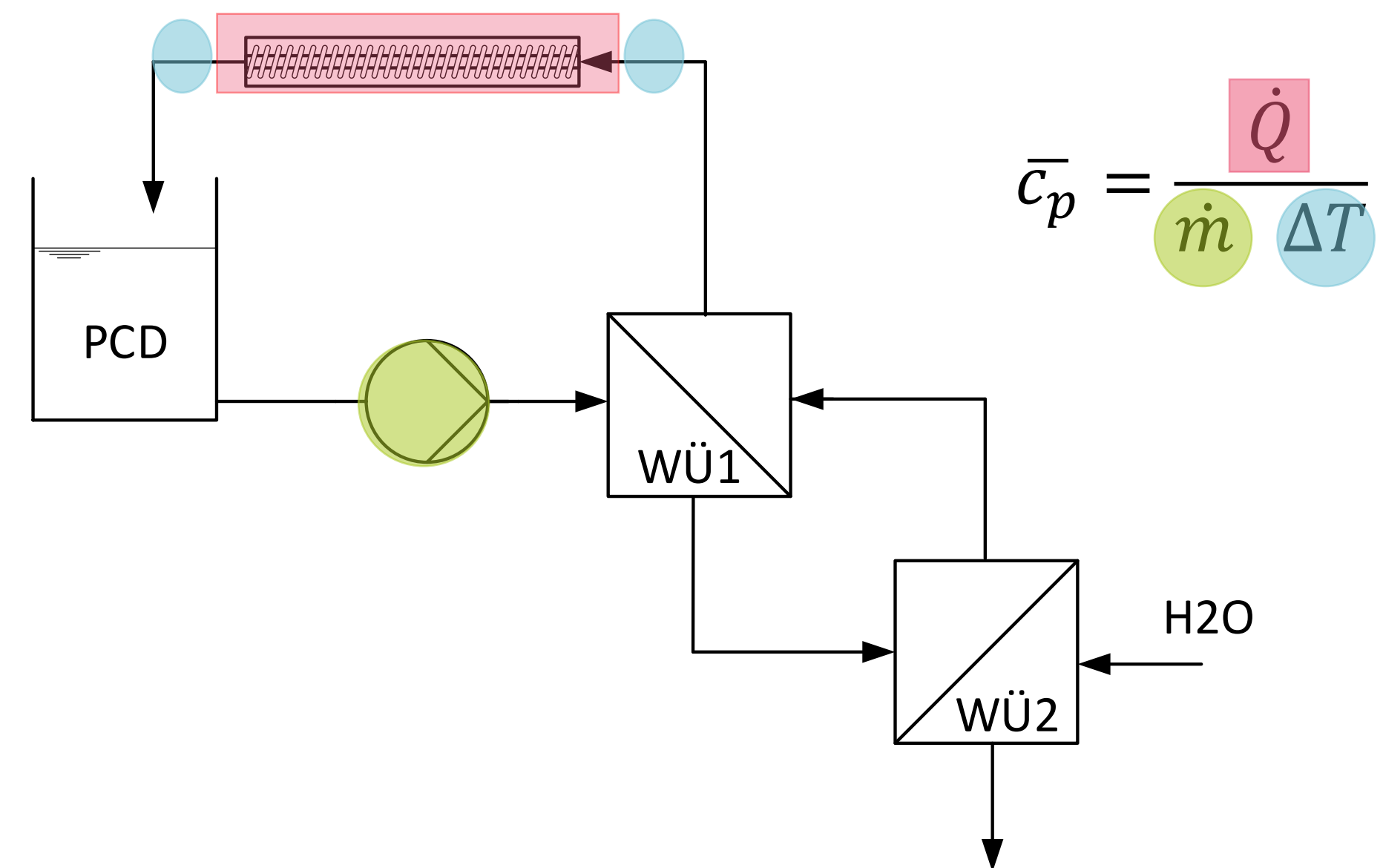

Preliminary Phase Change Dispersion

1. Overall reduction in c_p over cycles

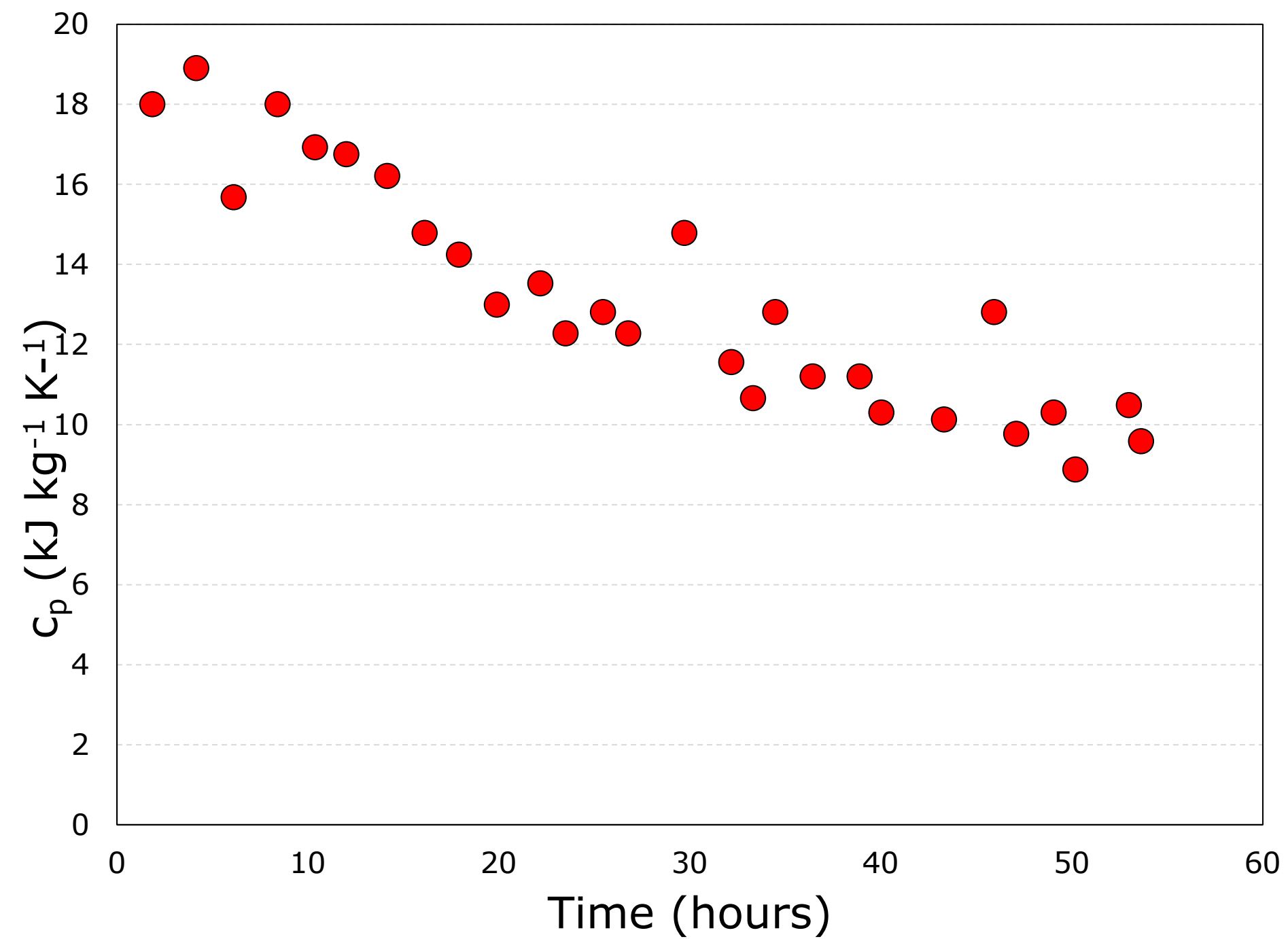

Increased degree of supercooling over cycles

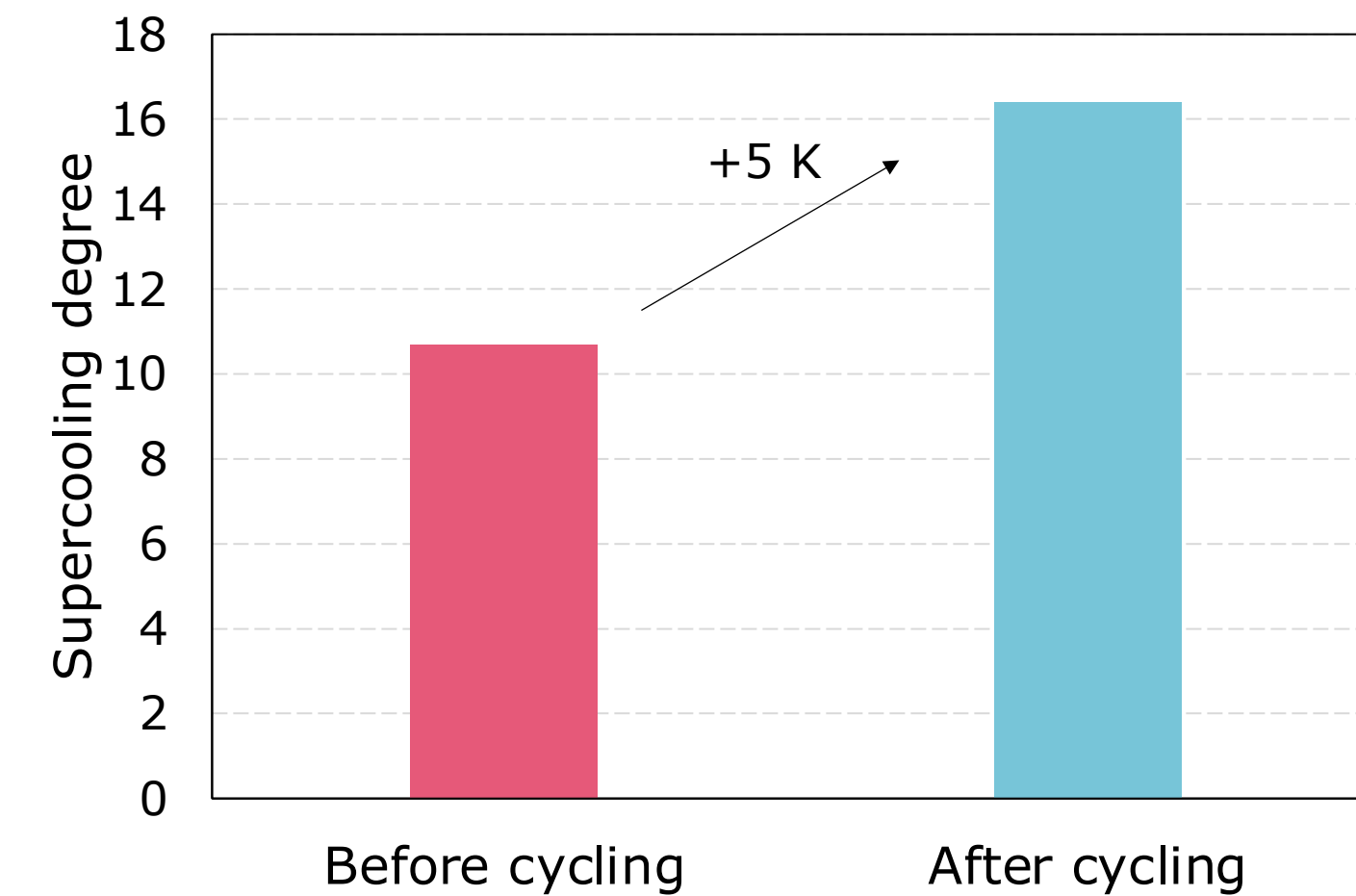

PCM dispersed phase crystallising out onto HX & piping

8% lower PCM concentration

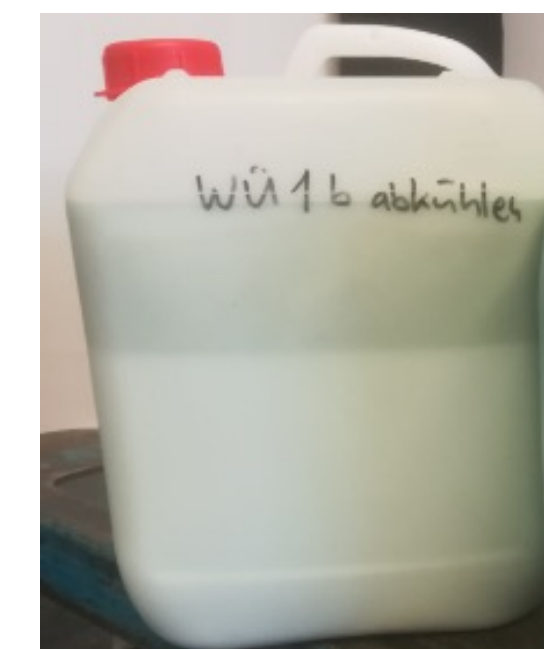

Materials & Methodology

A lot of formulations were made...

140



Materials and methodology : A novel approach

On **formulation 141** – we tried a different approach... *A modified surfactant system; manipulating the interface*

Steric stabilisation

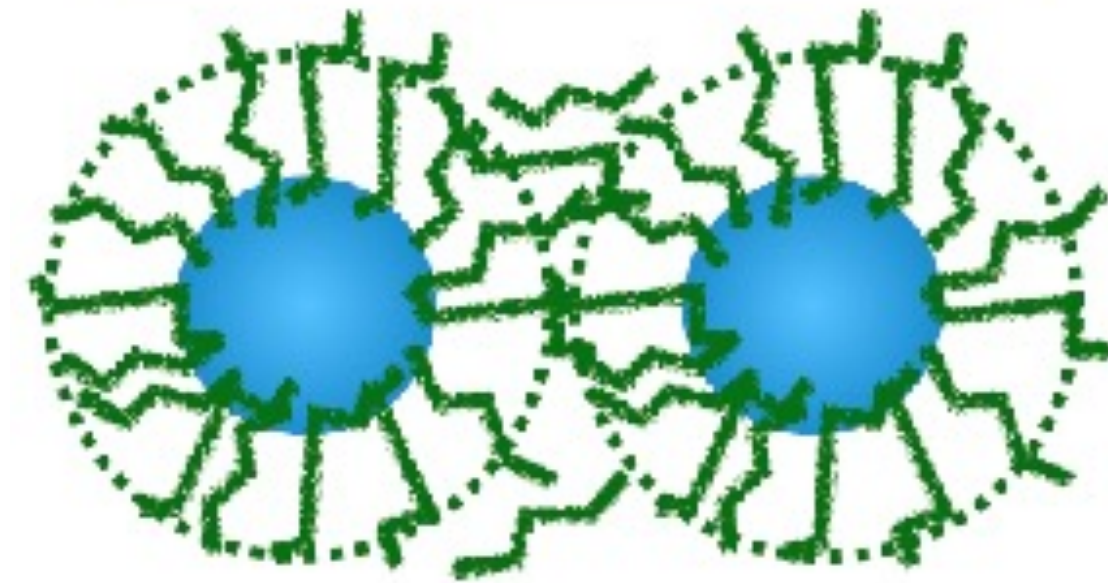

Templating

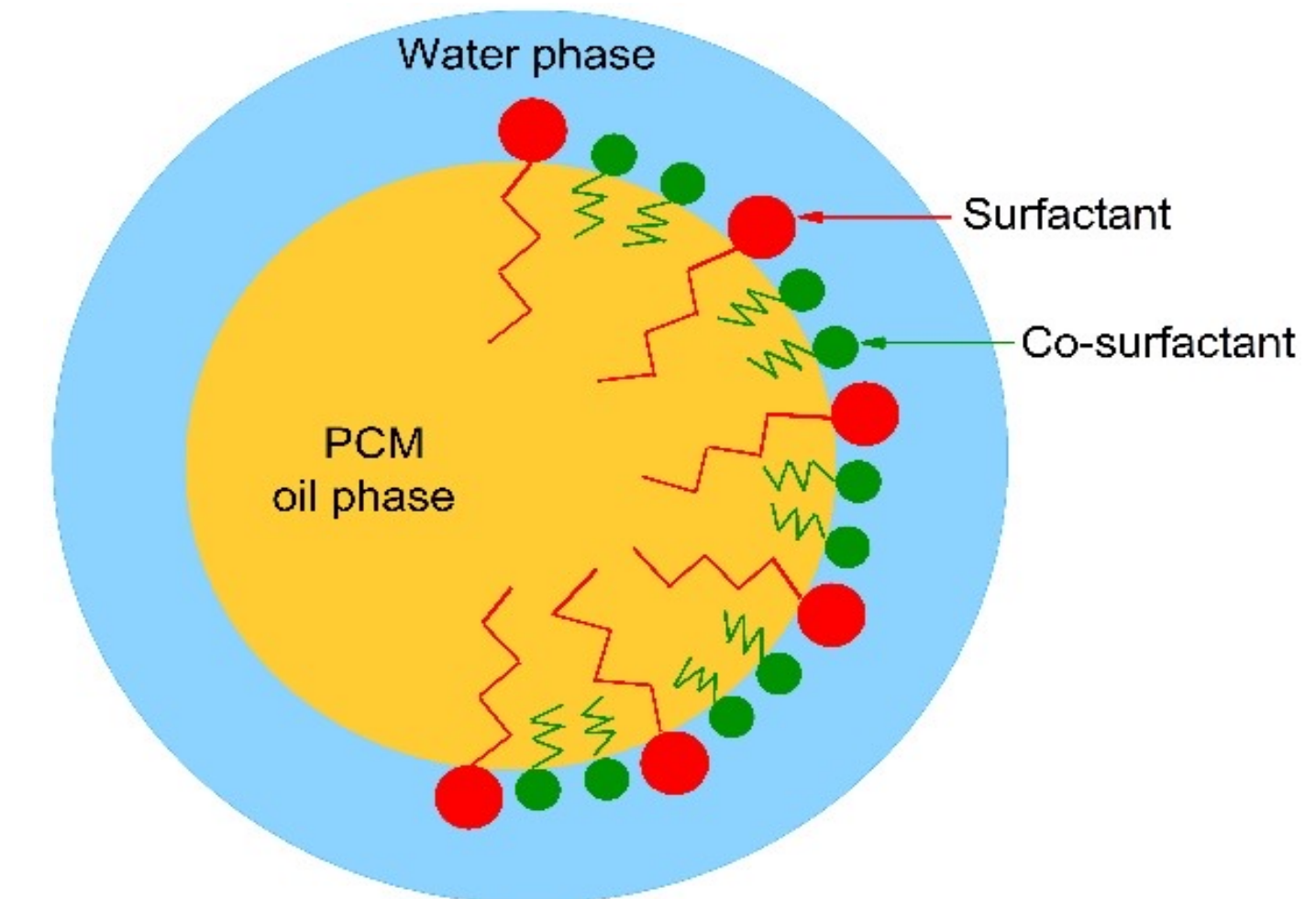
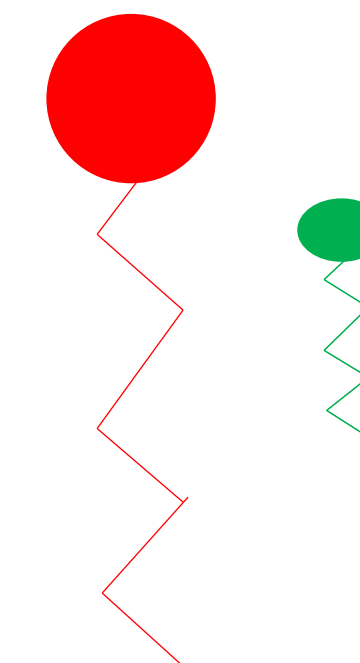
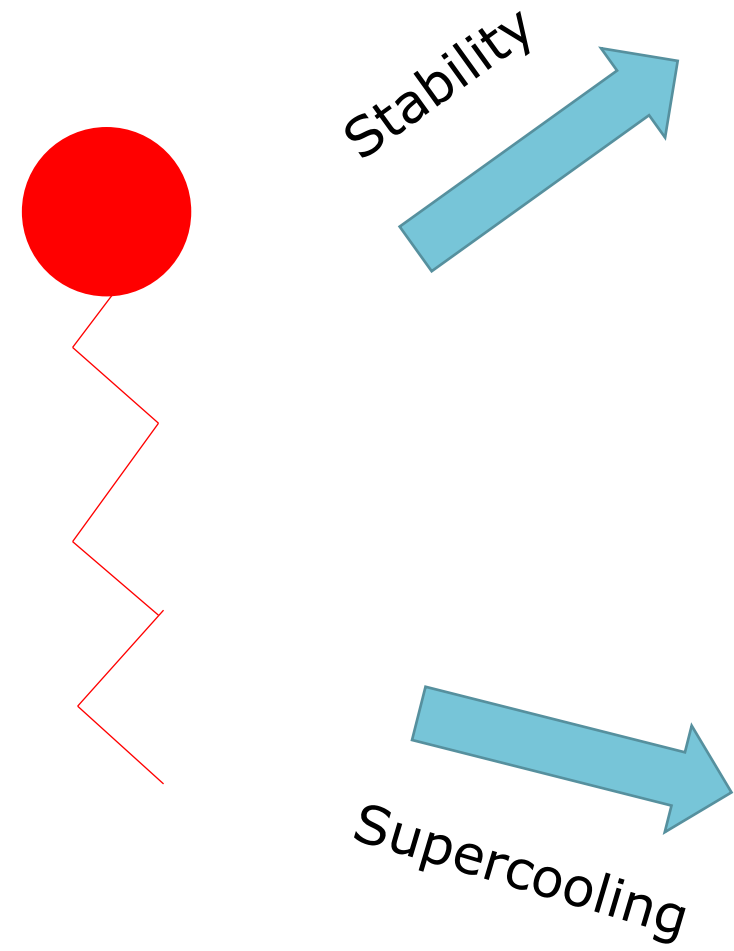
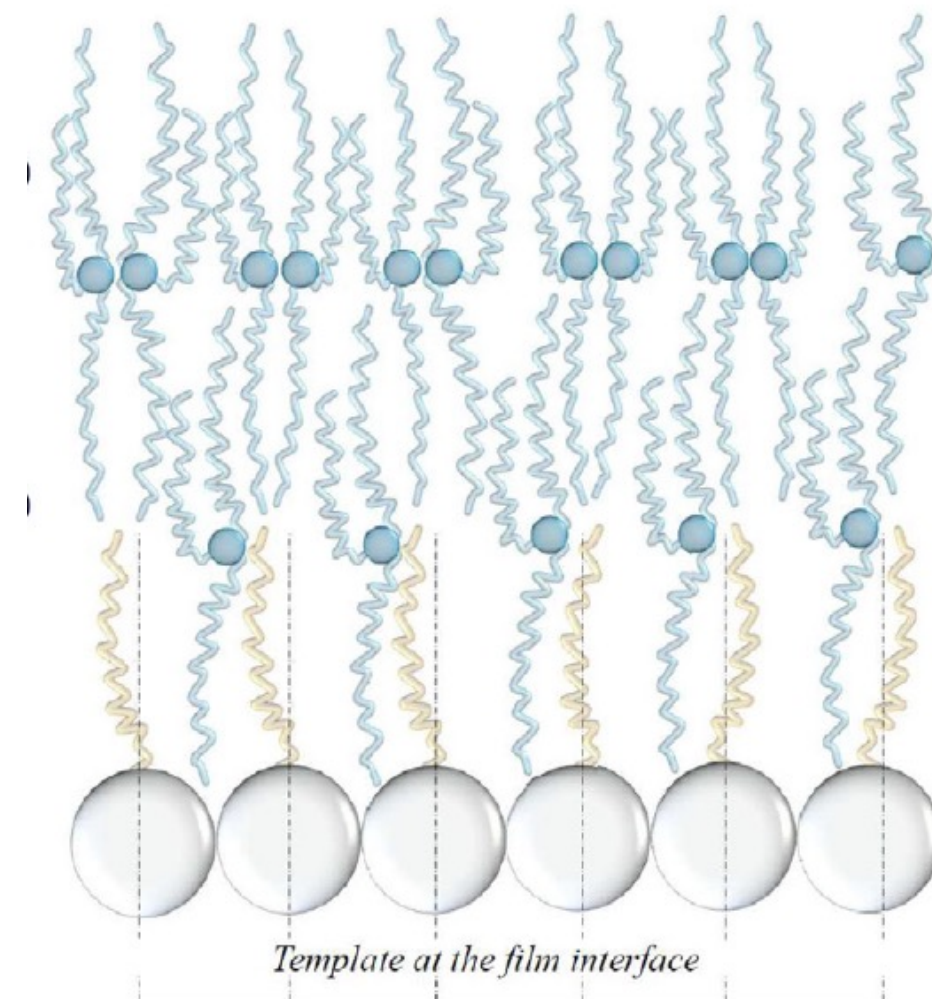

Results : New formulation

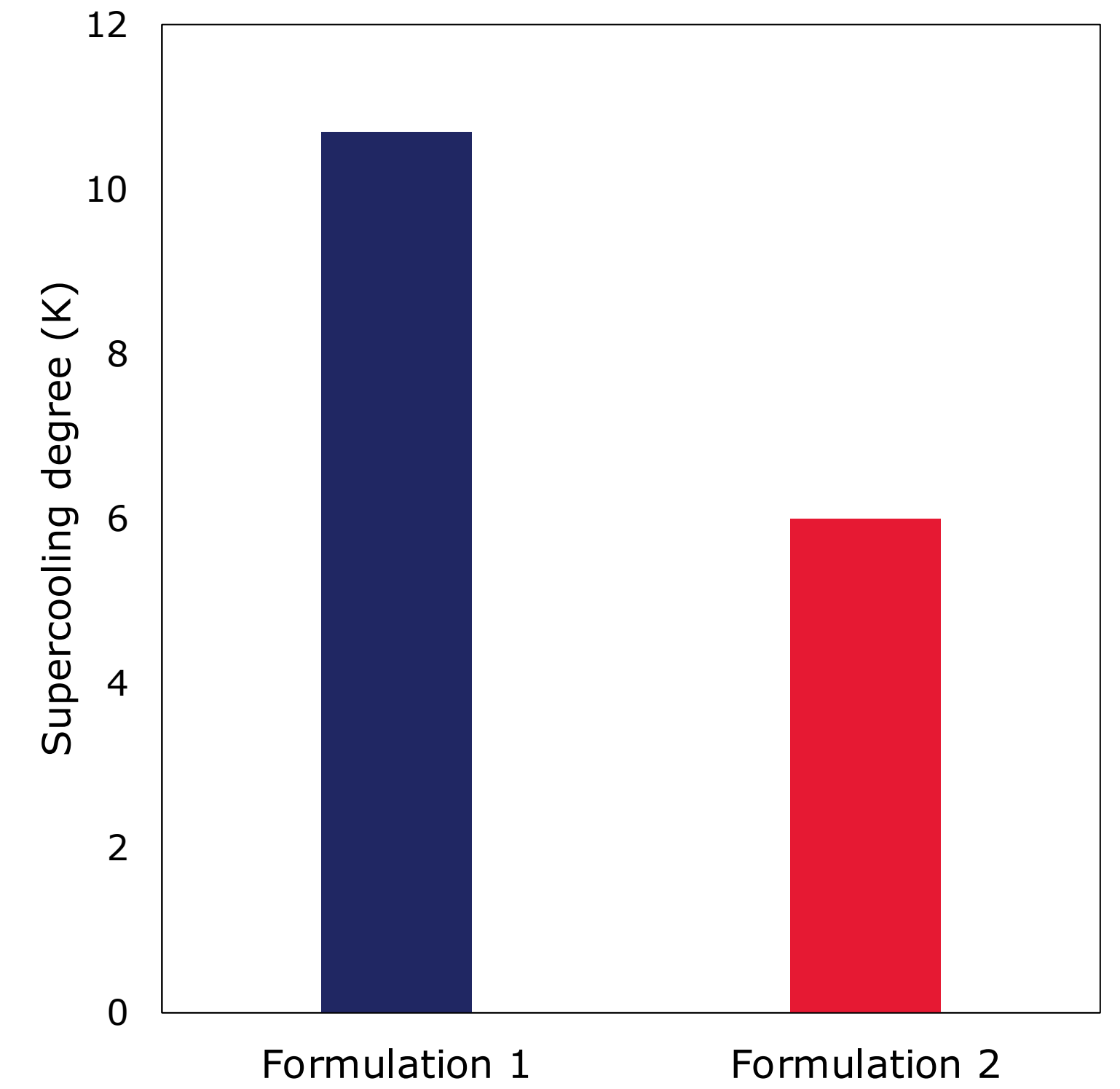
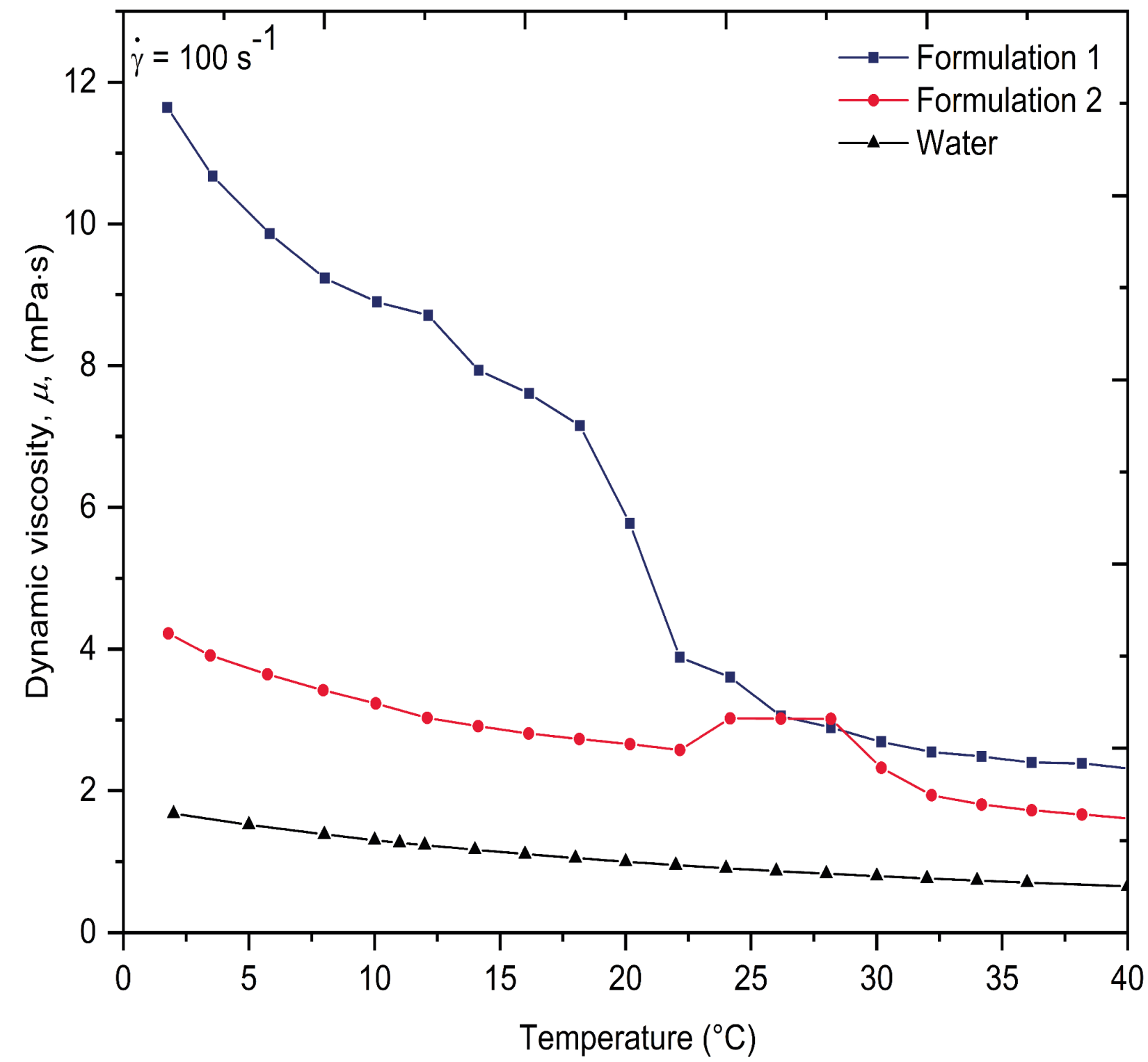
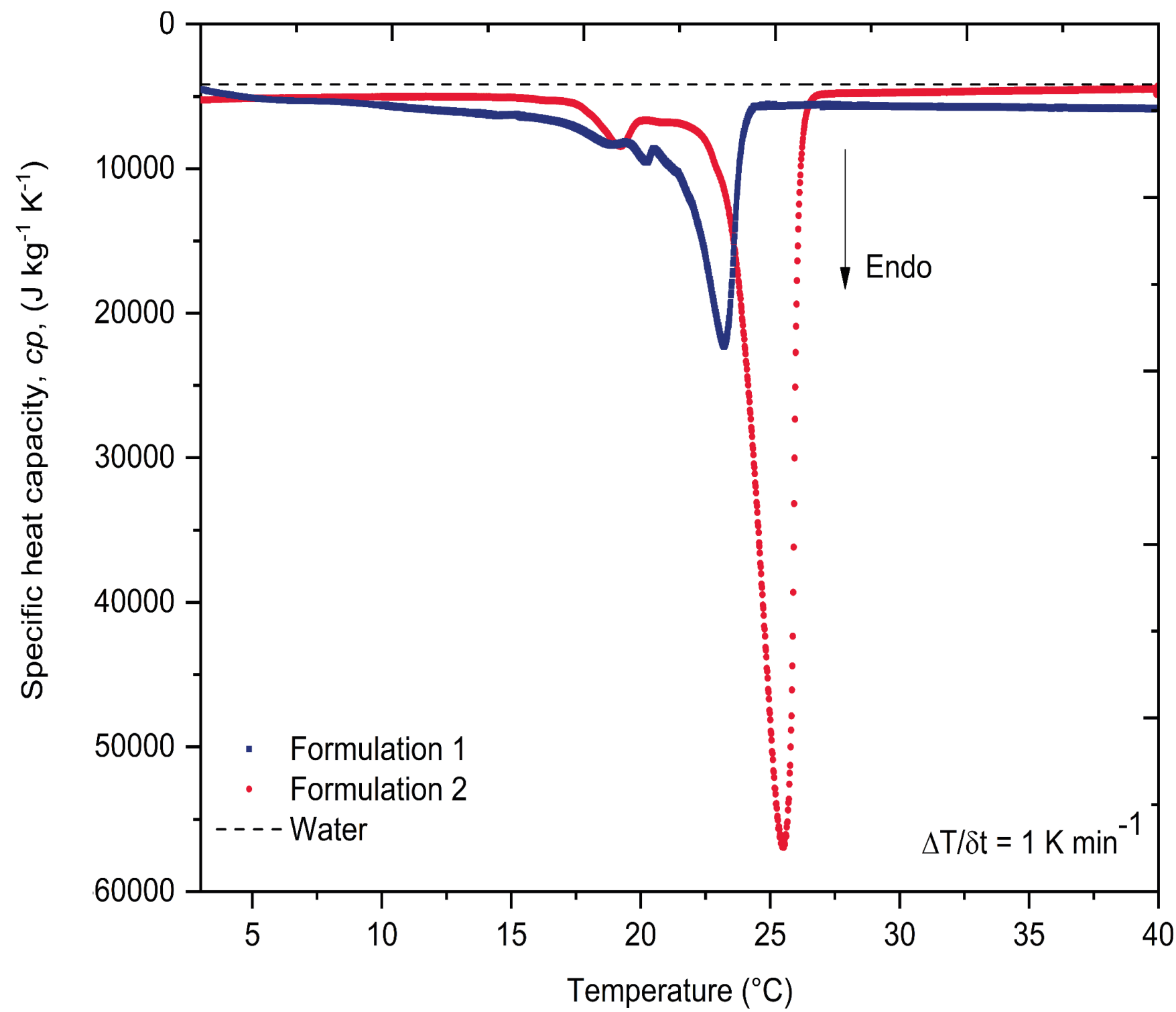

Results : New formulation

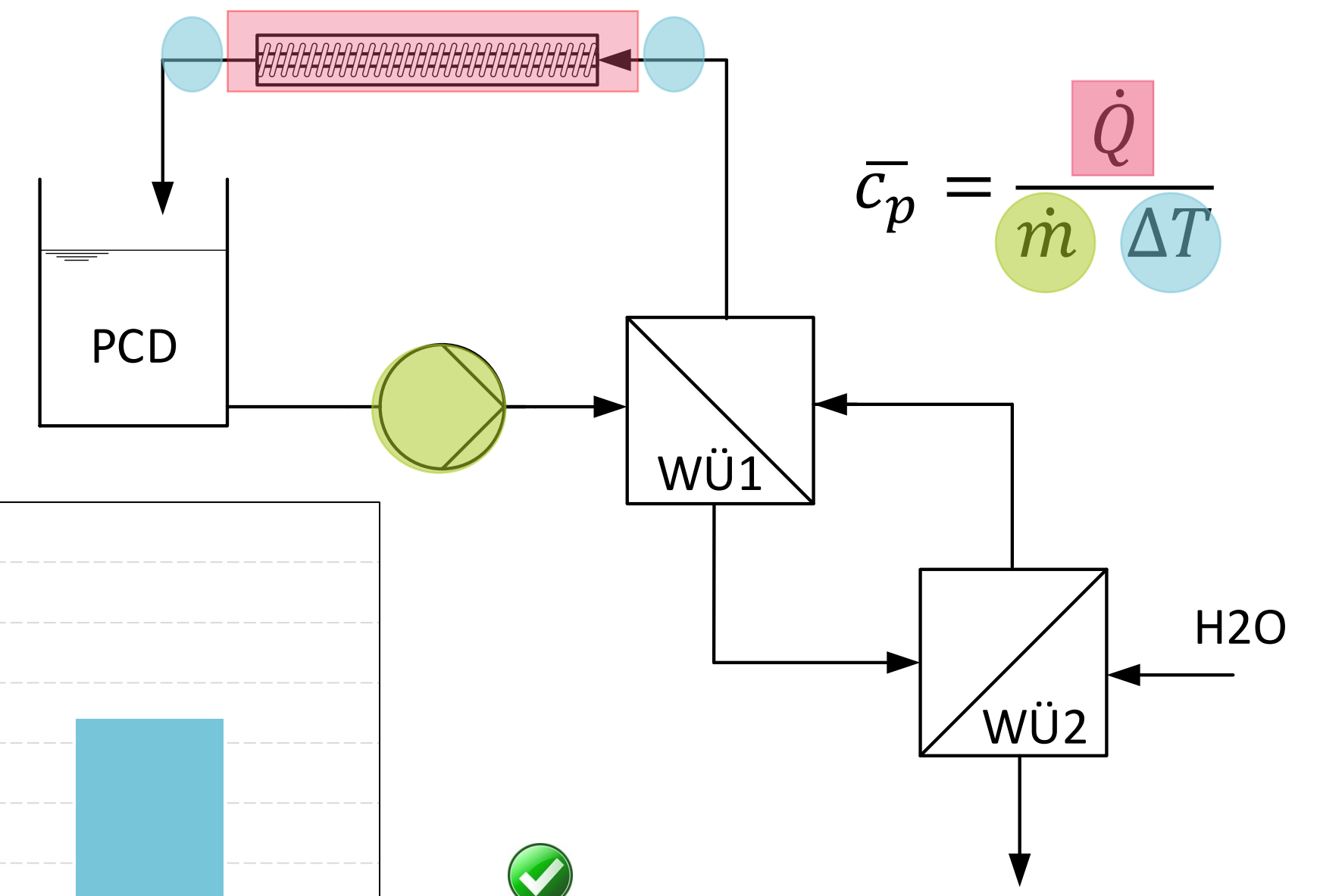
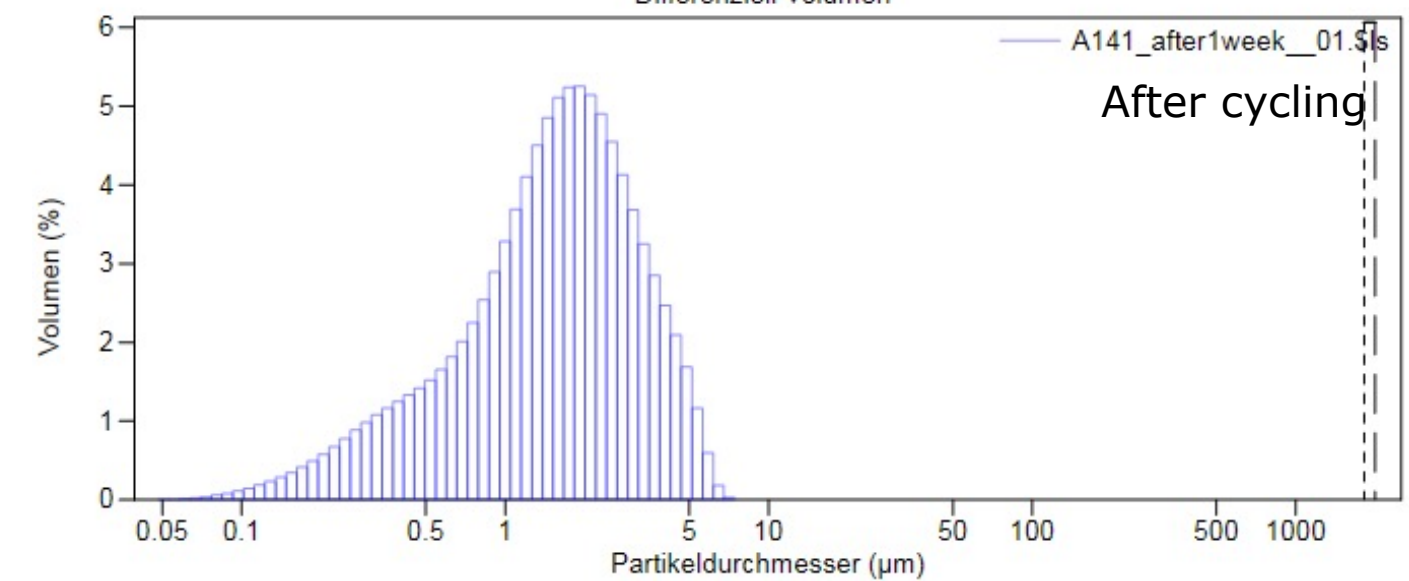
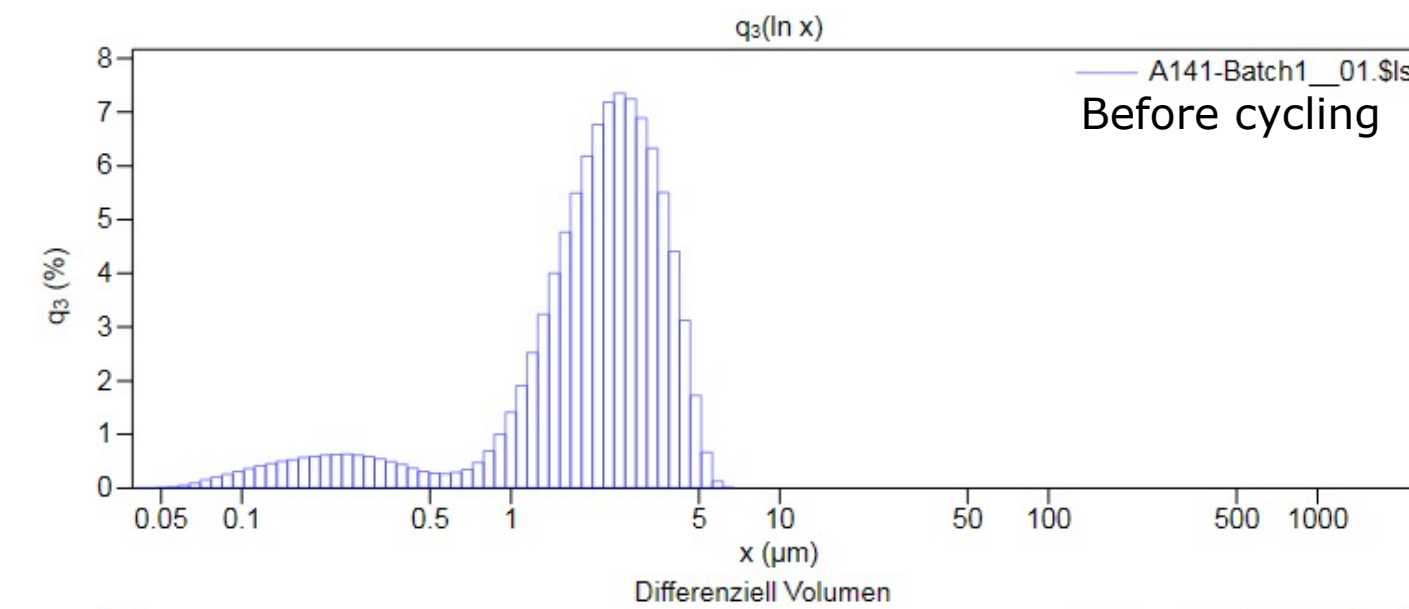
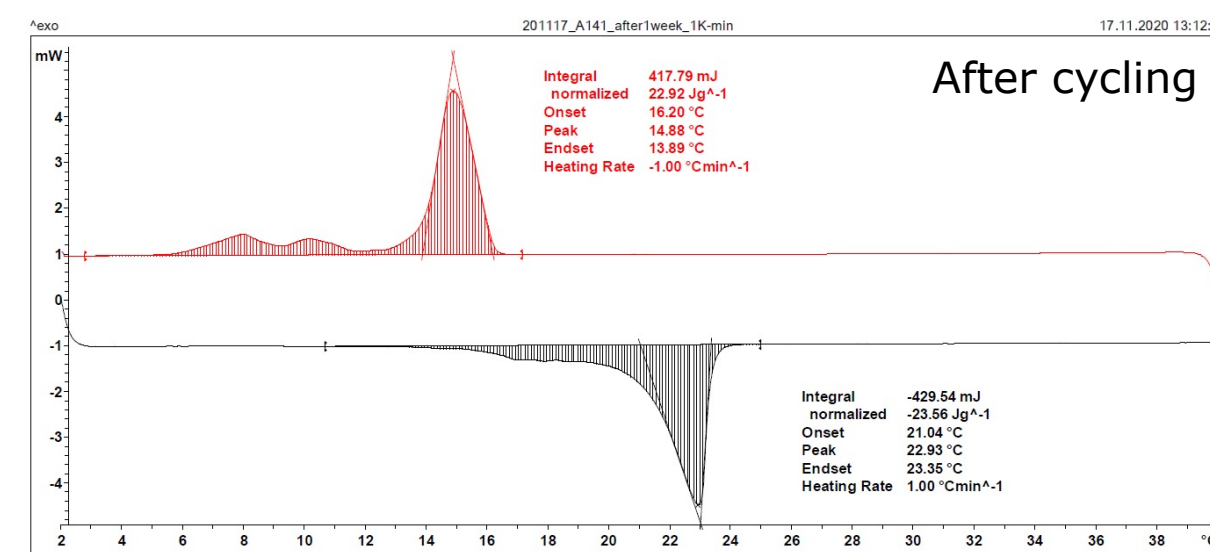
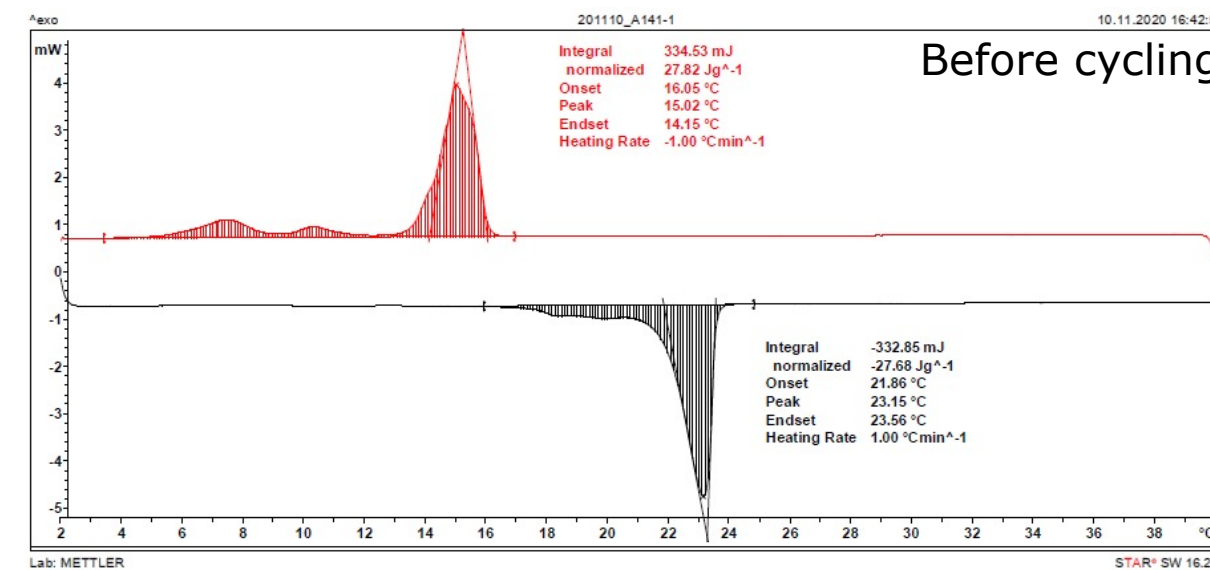
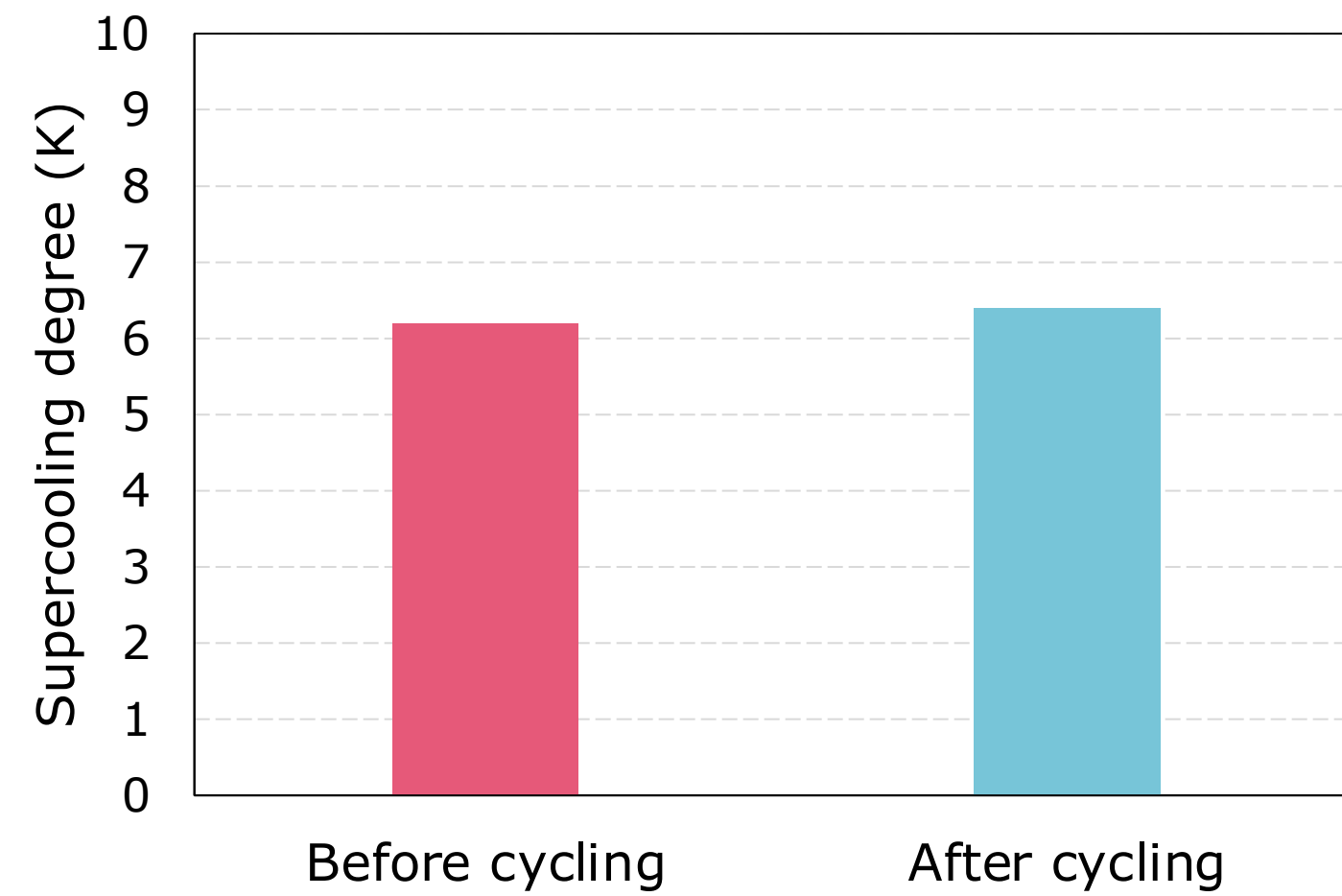
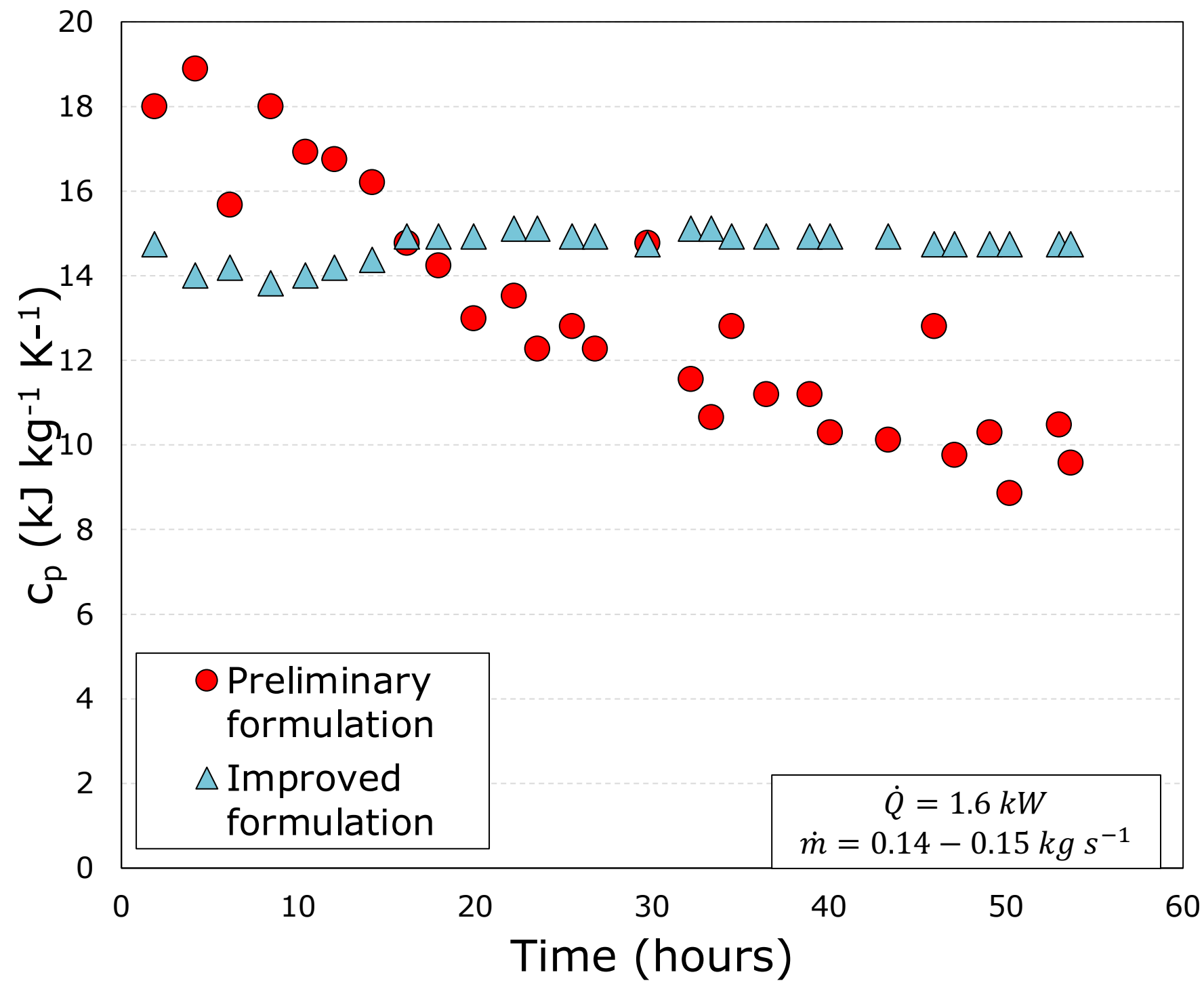

Future perspectives for phase change dispersions:

- Elucidate further **surfactant structure effects** to the reduction of **supercooling** and **thermophysical properties**
- Understand the the influence of **interface chemistry** on all the thermophysical properties of PCD
- **Apply the methodology** of PCD formulation to other temperature ranges/applications

Thank you!

Hochschule Luzern
Poppy O'Neill
Senior Research Associate

poppy.oneill@hslu.ch